



SÜDMO SVP SELECT OVERFLOW VALVES EAF+

SVP SELECT OVERFLOW VALVES

TYPE EAF+

FEATURING ADJUSTABLE SPRING LOAD ACTUATORS

DESCRIPTION

The EAF+ overflow valve series is an extension of the SVP Select Single Seat Valve series with adjustable set pressure actuator.

Apart from the SVP Select series there are also hygienic as well as aseptic designs available.

DEFINITION OVERFLOW VALVE

- Overflow valves **relieve pressure areas in cases of excessive pressure build-up** in closed spaces (piping, containers, tanks)
- The **output medium can be** discharged or returned/directed **into a closed system**
- In terms of the EC Pressure Equipment Directive 97/23/EC overflow valves are **not safety-equipped** parts and do not possess **any type of examination certificates**

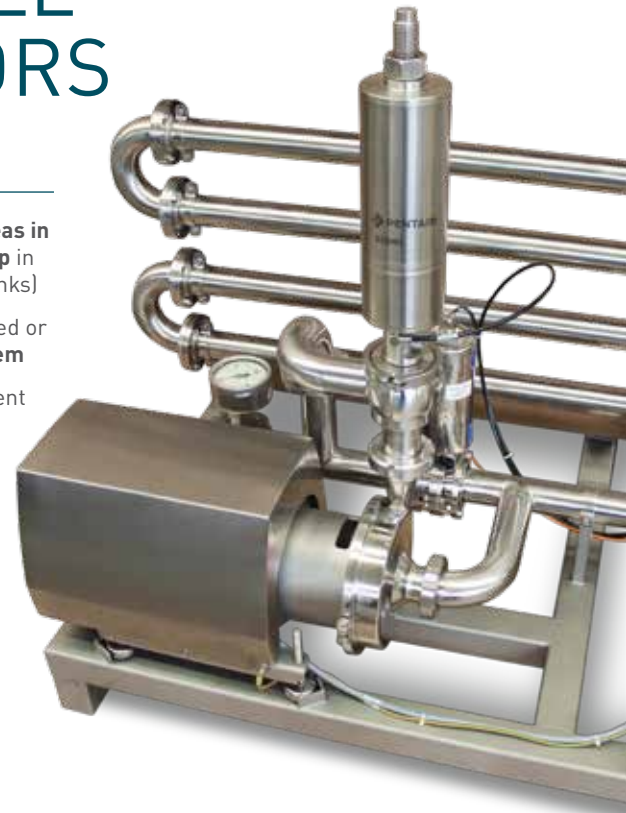

Advantages of SVP Select Type EAF+ Overflow Valves

- High operating pressures - up to 10 bar (145 psi)
- Simple adjustment of set pressure
- Low hysteresis of < 0.5 bar (7 psi)
- Standard with pneumatic lifting actuator for CIP cleaning
- Easy adaption of the IntelliTop 2.0
- Standard SVP Select seal kits
- Numerous industry authorizations and certifications

OVERFLOW VALVES APPLICATION EXAMPLES

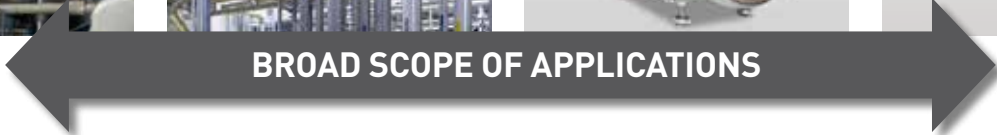
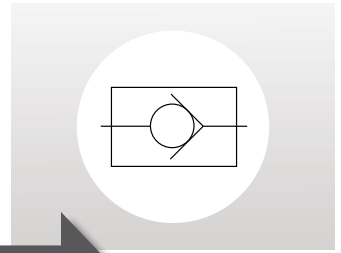

- To limit pressure on containers and tanks (e.g. CO₂ overlay)
- To limit pressure on piping systems
- Protection of pumps (circulatory function)
- Prevention of backflow in piping (3-A 53-06 compliant alternative to disk check valve)

OVERFLOW VALVE FUNCTION EXAMPLE: "PROTECTION OF A POSITIVE DISPLACEMENT PUMP"

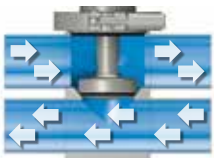

Pump builds up more medium than required

- Increased pressure in pipes after the pump

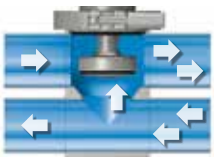

The overflow valve opens according to a pre-adjusted set pressure

- The medium flows either entirely or partially back through the overflow valve into the pipes before the pump, and is "sucked" back through the pump. This creates a circulatory function.
- Pressure build-up after the pump is restricted

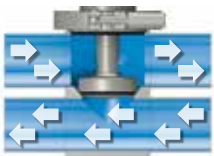

If pressure after the pump drops below the set pressure value of the overflow valve, the valves will close

- The entire flow is completely directed to "bottling"

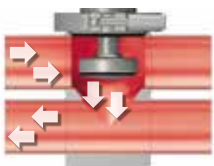

During CIP cleaning, the overflow valve can be opened via an integrated pneumatic lifting actuator

- The seat area of the overflow valves can be cleaned
- The piping system can be cleaned without flow through the pump

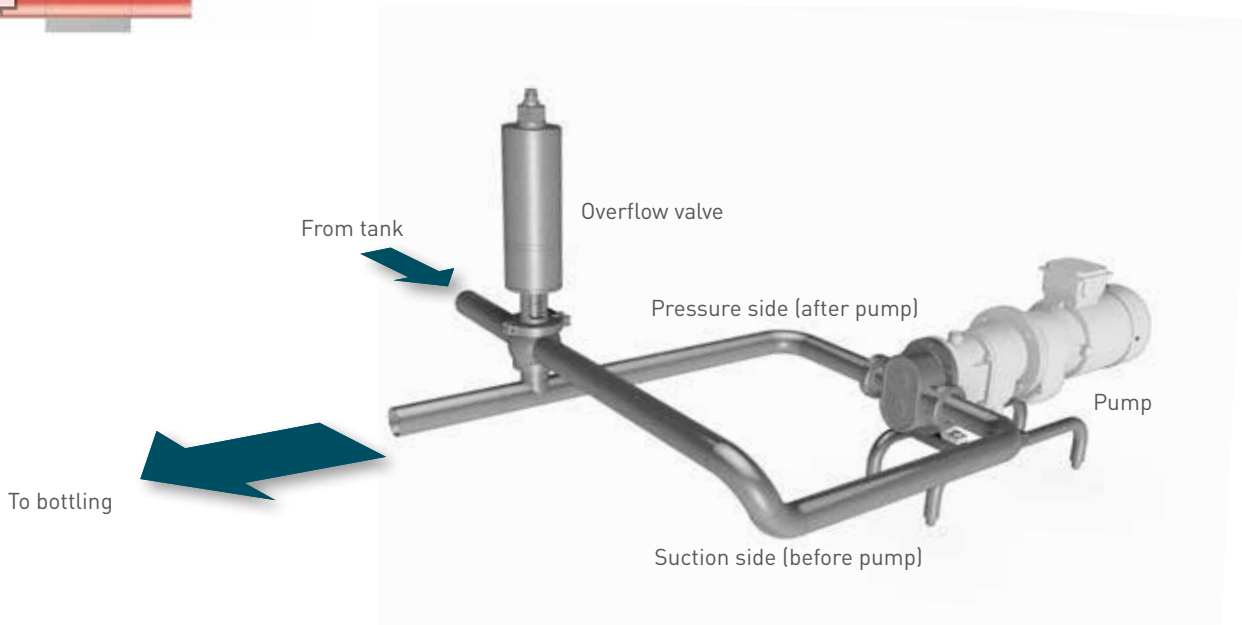

ACTUATOR CONCEPT EAF+

Function

The set pressure of the overflow valve is defined in the actuator by the tension of the pressure spring. If pipe pressure exceeds set pressure, the valve will open and the medium will be discharged.

Adjusting Set Pressure

Within a specific range, the spring tension can be adjusted with a bolt. If the adjustment range is insufficient, the actuator can be switched to an execution with higher or lower adjustment range.

Lift Function

The standard EAF+ actuator uses a pneumatic lift function to open the valve. This is required for:

- CIP cleaning of the seat area
- Pump bypass during CIP cleaning

Total hysteresis < 0.5 bar (7 psi)

The concept of the EAF+ overflow valve is based on friction optimization. Among other features, the piston has been coupled for the lift function to proven any additional friction. This results in an excellent hysteresis value of < 0.5 bar (7 psi).



TECHNICAL SPECIFICATIONS TYPE EAF+

Set pressure	0.5 / 1.0 – 10.0 bar (7 / 15 - 145 psi) depending on drive size, version, and nominal diameter
Hysteresis	< 0.5 bar (7 psi)
Available nominal diameters	DN 25-100 / OD Tube 1.0"-4.0" *

Further technical information such as operating temperature range, maximal operating pressures, CVs values, etc. correspond to the SVP Select single-seat valve series and can be found in the equivalent documents.

* Nominal diameters < DN 25/1.0" and > DN 100/4.0" on request

ACTUATOR TYPE EAD*

Also available as an option: pneumatic version without spring tension (Type EAD). The overflow valve set pressure is defined by pressure overlay of the actuator piston. To set the overlay pressure, and subsequently, the set pressure of the overflow valves, an external filter pressure regulator is required.

Advantages:	No spring rates
Disadvantages:	No safety position in case of air outage



PENTAIR SÜDMO GMBH

INDUSTRIESTRASSE 7, 73469 RIESBÜRG, GERMANY WWW.SUEDMO.DE

All Pentair trademarks and logos are owned by Pentair. All other brand or product names are trademarks or registered marks of their respective owners. Because we are continuously improving our products and services, Pentair reserves the right to change specifications without prior notice.

Pentair is an equal opportunity employer.

ID-No.: 2222241 - Overflow E-1/15 © 2015 Pentair - All Rights Reserved.